

FD3-55

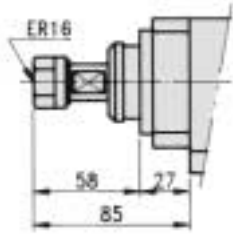

FD3-55-ER16

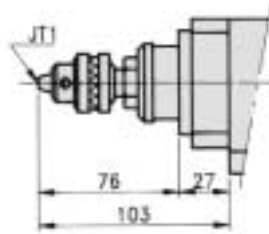

FD3-55-JT1

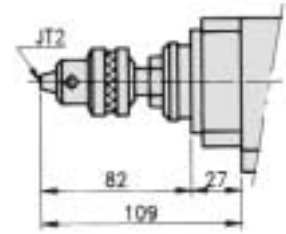

FD3-55-JT2

FD3-80

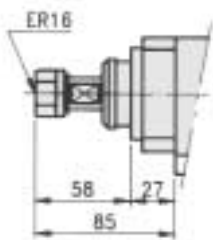

FD3-80-ER16

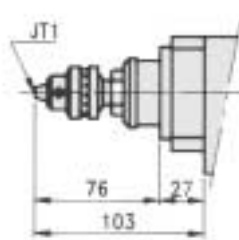

FD3-80-JT1

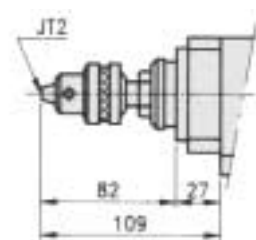

FD3-80-JT2

FD55-80

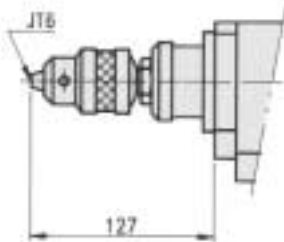

FD55-80-JT6

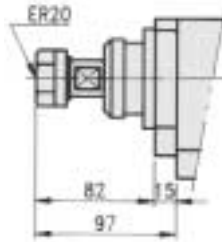

FD55-80-ER20

FD56-100

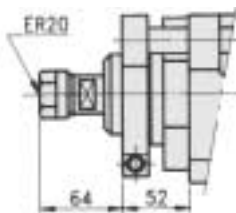

FD56-100-ER20

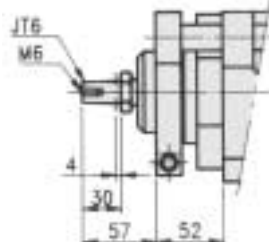

FD56-100-JT6

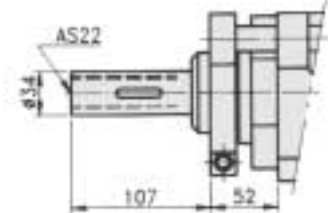

FD56-100-AS22

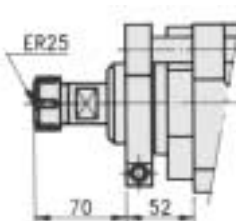

FD56-100-ER25

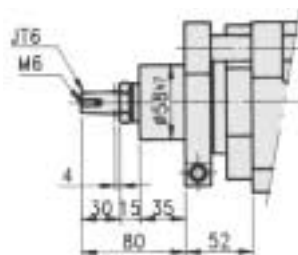

FD56-100-JT6 Multi

SPINDLE OPTIONS FOR METRIC UNITS

FD6-130/FTD63 (DRILLING)

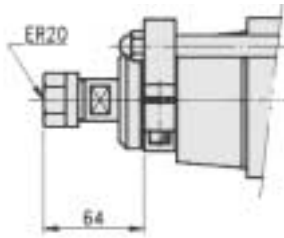

**FD6-130-ER20
FTD63-ER20**

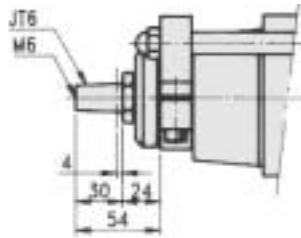

**FD6-130-JT6
FTD63-JT6**

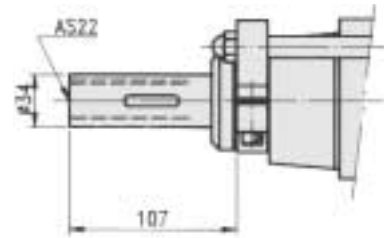

**FD6-130-AS22
FTD63-AS22**

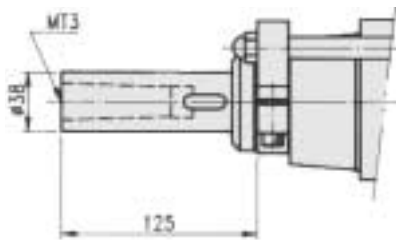

**FD6-130-MT3
FTD63-MT3**

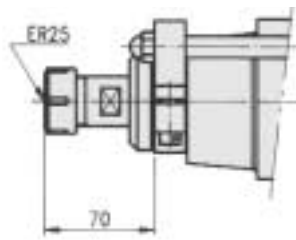

**FD6-130-ER25
FTD63-ER25**

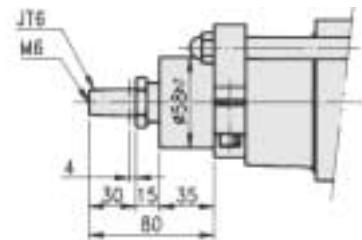

**FD6-130-JT6 Multi
FTD63-JT6 Multi**

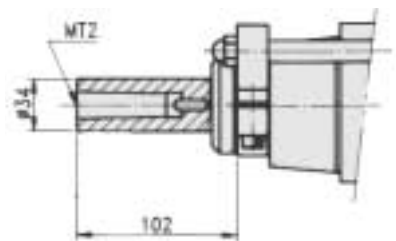

**FD6-130-MT2
FTD63-MT2**

FD62-100

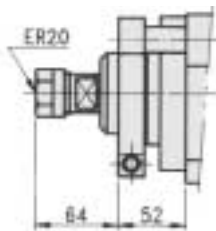

FD62-100-ER20

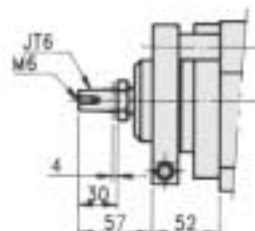

FD62-100-JT6

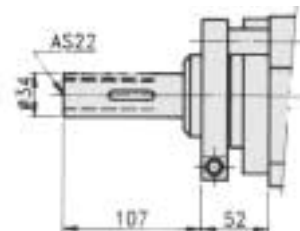

FD62-100-AS22

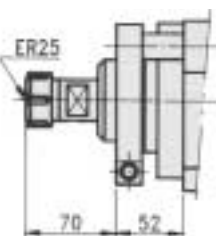

FD62-100-ER25

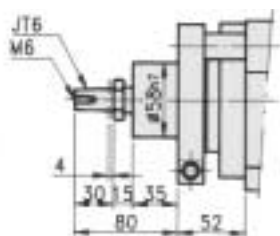

FD62-100-JT6 Multi

SPINDLE OPTIONS FOR METRIC UNITS

FD7-150

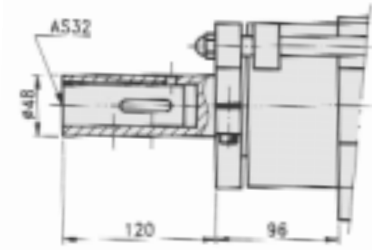

FD7-150-AS32

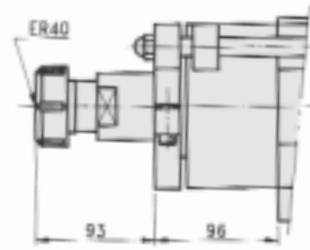

FD7-150-ER40

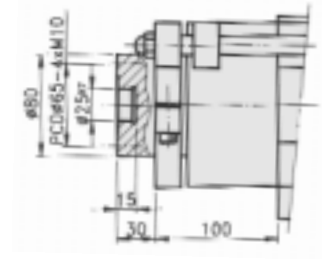

FD7-150-FB30

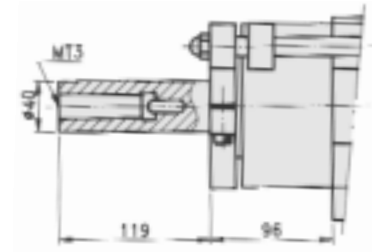

FD7-150-MT3A

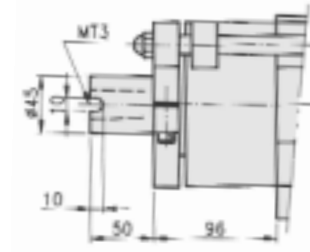

FD7-150-MT3B

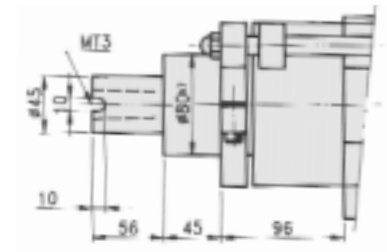

FD7-150-MT3B Multi

FD75-100

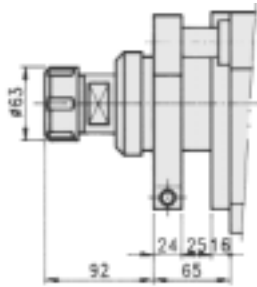

FD75-100-ER40

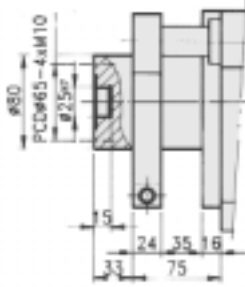

FD75-100-FB30

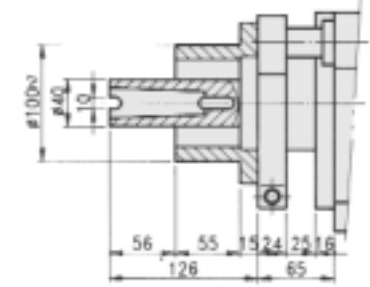

FD75-100-MT3A Multi

FD8-150

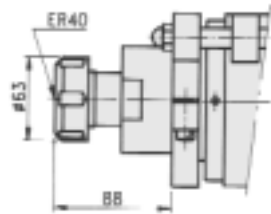

FD8-150-ER40

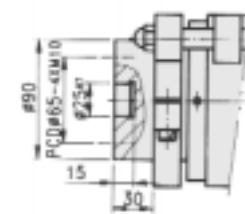

FD8-150-FB30

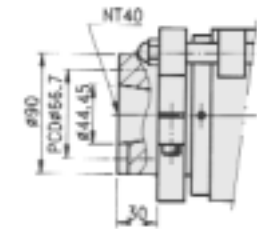

FD8-150-NT40

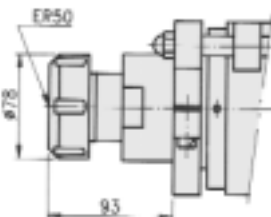

FD8-150-ER50

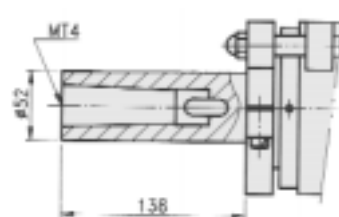

FD8-150-MT4A

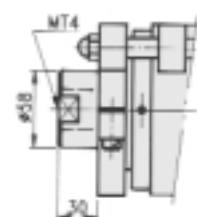

FD8-150-MT4B

SPINDLE OPTIONS FOR METRIC UNITS

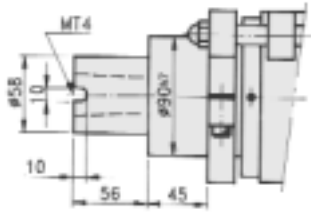

FD8-150-MT4B Multi

FD85-100

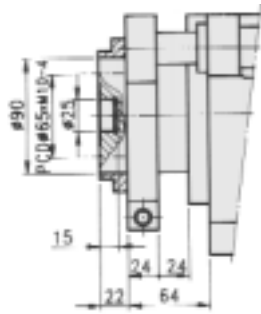

FD85-100-FB30

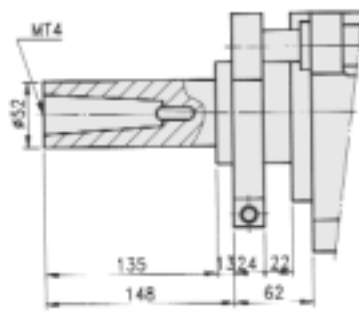

FD85-100-MT4A

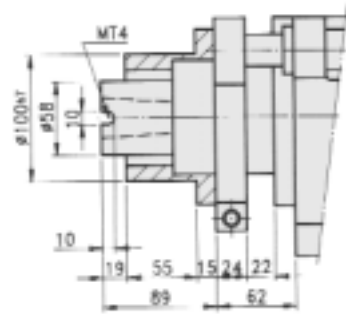

FD85-100-MT4B Multi

F2N-60

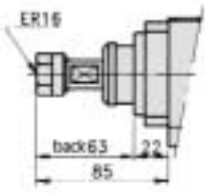

F2N-60-ER16

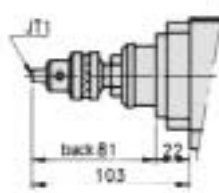

F2N-60-JT1

F6N-60

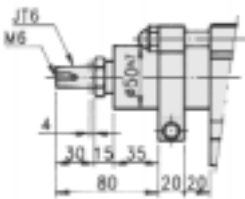

F6N-60-JT6

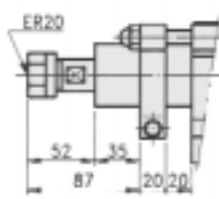

F6N-60-ER20

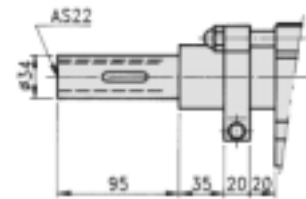

F6N-60-AS22

F7N-80

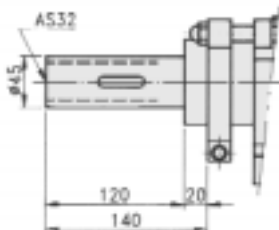

F7N-80-AS32

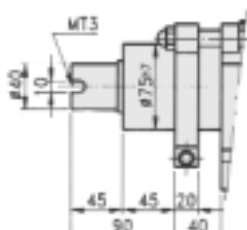

F7N-80-MT3B Multi

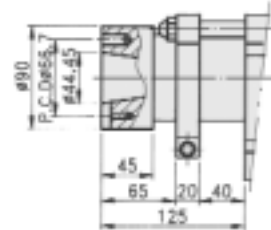

F7N-80-NT40

SPINDLE OPTIONS FOR METRIC UNITS

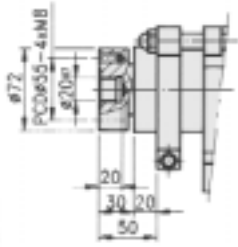

F7N-80-FB20

F8N-90

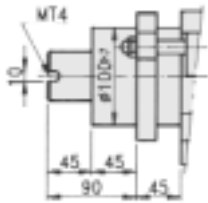

F8N-90-MT4B Multi

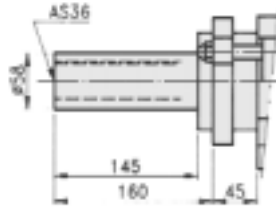

F8N-90-AS36

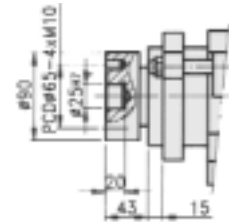

F8N-90-FB30

F85N-90

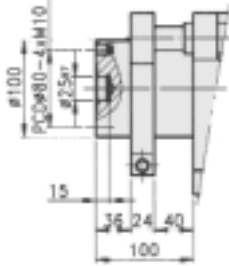

F85N-90-FB30

FTD9

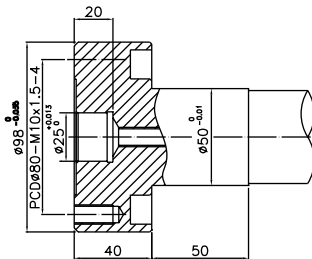

FTD9-FB45